



Peachtree Woodworking Supply Inc.[®]

"Your One Stop Supply Shop"[®]

COSTA MESA SHOW COUPONS

OVER
\$1300⁰⁰
in money saving
coupons inside

 **The Wood
Working
Shows**

Costa Mesa, California

Straight Ahead

**Over 100 Money SAVING
coupons inside!**

 **\$200
OFF
ADMISSION**

Show Dates:

November 1-3, 2013

Location:

OC Fair & Event Center
Fair Drive
Costa Mesa, CA 92626

Show Hours:

Fri. 12pm to 6pm,
Sat. 10am to 6pm,
Sun. 10am to 4pm

MUST BRING PRINTED COUPON TO THE SHOW TO REDEEM

This Coupon is NOT valid with online ticket purchases. Printed coupon must be presented at the time of show entry for discount to be received. Limit one per customer. Offer only valid at the Woodworking Shows. May NOT be combined with any other offer.

Pricing, pictorial and typographical errors are subject to correction at time of purchase.

NEW!
& only at Peachtree

TURNERS LASER GUIDE

Universal Mount, Real Time
Vessel Thickness Gauge

Accurately see your cutter location on the
outside of your vessel while it is spinning and
material is being removed



The Turners Laser Guide

enables you to know the location of a point on the cutting edge in real time even while the vessel is spinning and material is being removed. It utilizes a laser pointer to indicate the cutter position on the outside of the vessel while the cutter is actually inside the vessel and is otherwise impossible to accurately locate. The Universal Mounting Base allows the Turners Laser Guide to be attached to most any style, type or brand of hollowing tool. The Turners Laser Guide can be attached to either the turning tool ferrule or shaft ranging from 3/4" to 1-1/4" in diameter. With the stainless steel supports you can turn vessels 10" deep by 20" in diameter. The Turners Laser Guide can be set to show the position of the cutter or to show the offset to give you the ability to see the wall thickness of your vessel while it is spinning. The Support Arm Accessory Kit (sold separately) gives you the ability to use the Turners Laser Guide on vessels that are 20" deep by 38" in diameter.

NEW!

**LIVE
DEMO!**

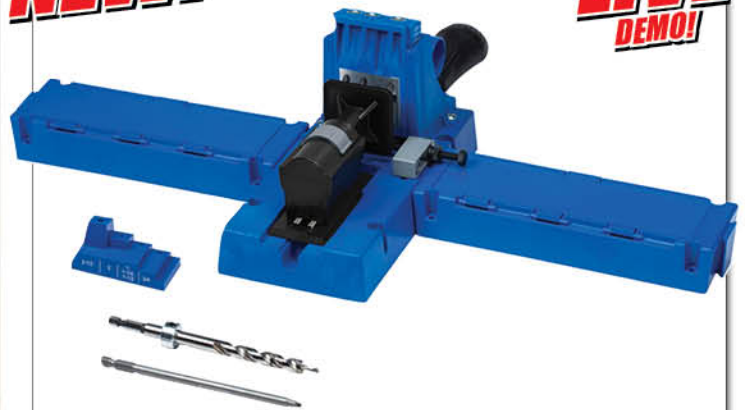

THE MOST ADVANCED KREG JIG YET!



The Kreg Jig® K5

incorporates the features of every Kreg Jig® that came before with upgrades you've never seen. That starts with an all-new clamping mechanism that you can adjust without tools or adjusting nuts to match your workpiece thickness. Just slide the clamp into place, "click" the large front-mounted clamp handle, and your jig is set to hold your workpiece tight every time. Plus, you'll find large support wings to hold your wider workpiece steady—and they have storage compartments inside. Add in a batch of other great features like a standard swiveling dust-collection port, spring-loaded stop for the Drill Guide Block, and, of course, the ability to remove the Guide Block for portable use, and you have, quite simply, the most advanced Kreg Jig® yet.

FREE!

Assorted Screw Kit

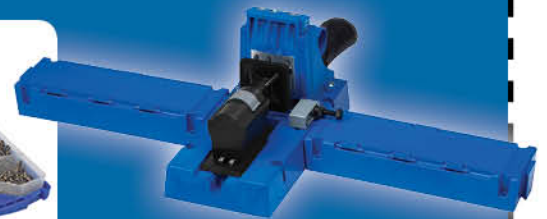

*with purchase of the Kreg
K-5 Pocket Hole Jig Package*

Coupon is only valid at the Show in the PEACHTREE WOODWORKING
SUPPLY BOOTH. While supplies last, no rain checks.



Kreg Jig Tool & Accessories



See the **NEW**
K5 KREG JIG
in **ACTION!**

Show
Package
Special!

The **Kreg**
Toolbox™

Catalog Price \$49.99
SHOW PRICE...
\$29.99 PLU# 4475

Coupon is only valid at the Show in the PEACHTREE WOODWORKING SUPPLY BOOTH. While supplies last, no rain checks.

FEATURING
THE **AUTOMAXX BENCH KLAMP!**

Klamp System Components Kit

SHOW PRICE...
\$99.99
You **SAVE**
\$40.95 PLU# 4468

Coupon is only valid at the Show in the PEACHTREE WOODWORKING SUPPLY BOOTH. While supplies last, no rain checks.

SHOW EXCLUSIVE **1000 Kreg Pockethole Screws**

500 ea. 1-1/4" fine #1507
500 ea. 1-1/4" coarse #1510

SHOW PRICE...
\$25.99 PLU# 4484

Coupon is only valid at the Show in the PEACHTREE WOODWORKING SUPPLY BOOTH. While supplies last, no rain checks.

Table & Stand
MASTER PACKAGE

Show Accessories Included:

- 1 ea. featherboard
- 1 ea. micro adjuster
- 1 ea. kreg set up bar set
- 1 ea. power switch
- 1 ea. caster 4 pack

SHOW PRICE...
\$599.99
You **SAVE** **\$105.93** PLU# 4464

Table, Fence & Stand Included

Coupon is only valid at the Show in the PEACHTREE WOODWORKING SUPPLY BOOTH. While supplies last, no rain checks.

FREE!
KREG SCREW SELECTOR WHEEL
WITH COMBO PACK PURCHASE

Kreg

**AUTOMAXX
3" & 6"
Face Clamp
Combo Pack**

Catalog Price
\$67.98

SHOW PRICE...

\$59.99
PLU# 4486

Coupon is only valid at the Show in the PEACHTREE WOODWORKING SUPPLY BOOTH. While supplies last, no rain checks.



Kreg

**Drawer
Mounting
Combo
Package**



Catalog Price
\$41.98

SHOW PRICE...

\$36.99
PLU# 4485



Coupon is only valid at the Show in the PEACHTREE WOODWORKING SUPPLY BOOTH. While supplies last, no rain checks.



**3 1/4 HP
ROUTER with
pre-drilled
plate**

SHOW PRICE...

\$289.99
PLU# 4469

You SAVE...
\$19.00

Coupon is only valid at the Show in the PEACHTREE WOODWORKING SUPPLY BOOTH. While supplies last, no rain checks.



**2 1/4 HP
ROUTER with
pre-drilled
plate**

SHOW PRICE...

\$249.99
PLU# 4470

You SAVE...
\$29.00

Coupon is only valid at the Show in the PEACHTREE WOODWORKING SUPPLY BOOTH. While supplies last, no rain checks.

Tablesaw Zero Clearances

**SELECT THE CORRECT
ZERO CLEARANCE**

- Measure the insert (length by width by thickness)
- Make note of the make and model of your saw
- Make note of the year the saw was manufactured
- Bring the zero clearance to the show for a perfect match

**SPECIAL SHOW
PRICING!**



Sili-Glue up Products

**Non-Stick
Silicone
for quick
& easy
Cleanup!**

Sili Stik 2 Pack

Apply glue in dowel holes and biscuit slots

NEW!
& ONLY AT PEACHTREE



SHOW PRICE...
\$5⁹⁹

PLU# 4019

Coupon is only valid at the Show in the PEACHTREE WOODWORKING SUPPLY BOOTH. While supplies last, no rain checks.

NEW! Sili Tray & Comb

Perfect for larger glue applications

& ONLY AT PEACHTREE



SHOW PRICE...
\$8⁹⁹

PLU# 4021

Coupon is only valid at the Show in the PEACHTREE WOODWORKING SUPPLY BOOTH. While supplies last, no rain checks.

Sili Glue Brush

Silicone Glue Brush, with Bonus 1/2" Head

NEW!
& ONLY AT PEACHTREE

SHOW PRICE...
\$3⁹⁹

PLU# 1203



Coupon is only valid at the Show in the PEACHTREE WOODWORKING SUPPLY BOOTH. While supplies last, no rain checks.

Sili-GlueKit

NEW!
& ONLY AT PEACHTREE

SHOW PRICE...
\$15⁹⁹

PLU# 4020

Coupon is only valid at the Show in the PEACHTREE WOODWORKING SUPPLY BOOTH. While supplies last, no rain checks.



Peachtree Woodworking Supply Inc.®

"Your One Stop Supply Shop"®

BUY FOUR GET ONE FREE!

Offer includes 5" 5
hole & 5" 8 hole of
any grit Mirka gold
sandpaper 50 packs



Coupon is only valid at the Show in the PEACHTREE WOODWORKING
SUPPLY BOOTH. While supplies last, no rain checks.

3X NORTON 30 Pack Sheet Assortment

SHOW PRICE...
\$9⁹⁹

PLU# 32

Coupon is only valid at the Show in the PEACHTREE WOODWORKING
SUPPLY BOOTH. While supplies last, no rain checks.

3M 8 Pack of Assorted Sanding Sponges



SHOW PRICE...
\$7⁹⁹

PLU# 4762

Coupon is only valid at the Show in the PEACHTREE WOODWORKING
SUPPLY BOOTH. While supplies last, no rain checks.

Deluxe Doweling Kit



Catalog Price
\$84.99

SHOW PRICE...
\$49⁹⁹

PLU# 740

Coupon is only valid at the Show in the PEACHTREE WOODWORKING
SUPPLY BOOTH. While supplies last, no rain checks.

5" Sanding Mouse



SHOW PRICE...
\$5⁹⁹

PLU# 33

5" Sandpaper Hook & Loop Discs
NOT INCLUDED

Coupon is only valid at the Show in the PEACHTREE WOODWORKING
SUPPLY BOOTH. While supplies last, no rain checks.

BESSEY 90° Clamp 4 pack



Catalog Price
\$119.99

SHOW PRICE...
\$89⁹⁹

PLU# 787

Coupon is only valid at the Show in the PEACHTREE WOODWORKING
SUPPLY BOOTH. While supplies last, no rain checks.



Peachtree Woodworking Supply Inc.®

"Your One Stop Supply Shop"®

NEW



PANEL MAX XL

Glue Panels as Large as 50" in Width!

The NEW Panel Max XL has extra long rails that allow you to glue panels up to 50" wide! Create large or smaller panels with great looking professional results every time with the Panel Max XL Glue Press System. The Panel Max XL makes stronger, more uniform joints than standard bar or pipe clamps. It applies even uniform pressure to the stock since it completely surrounds the work piece, which creates superior quality joints with much less hassle. The system also cuts the surface area required down about 90% since it mounts vertically to your shop wall while the stock is drying. The Panel Max XL can be easily cleaned of glue and residue build up and is designed to provide years of professional looking results every time you use it.

NEW!
& ONLY AT PEACHTREE

Flex-A-Jaw

The Ultimate Hand Clamp

SHOW PRICE...

\$799
PLU# 1387



Coupon is only valid at the Show in the PEACHTREE WOODWORKING SUPPLY BOOTH. While supplies last, no rain checks.

Bessey K-body Revo Cabinet Makers 4 Pack



SHOW PRICE...

\$169⁹⁹
PLU# 770

Coupon is only valid at the Show in the PEACHTREE WOODWORKING SUPPLY BOOTH. While supplies last, no rain checks.

EXTRA DEEP THROAT C-Clamp



SHOW PRICE...
\$10⁹⁹
PLU# 739

Coupon is only valid at the Show in the PEACHTREE WOODWORKING SUPPLY BOOTH. While supplies last, no rain checks.

2-1/2" x 6" Light Duty Clamp



SHOW PRICE...

\$4⁹⁹
PLU# 3408

Coupon is only valid at the Show in the PEACHTREE WOODWORKING SUPPLY BOOTH. While supplies last, no rain checks.



Peachtree Woodworking Supply Inc.®

"Your One Stop Supply Shop"®

Clamp Racks

\$14⁹⁹
to
\$29⁹⁹



Coupon is only valid at the Show in the PEACHTREE WOODWORKING SUPPLY BOOTH. While supplies last, no rain checks.

Adjustable Fence Clamps

SHOW PRICE...
\$15⁹⁹
a pair



PLU# 3324

Coupon is only valid at the Show in the PEACHTREE WOODWORKING SUPPLY BOOTH. While supplies last, no rain checks.

Swivel Vise with Suction Base



Catalog Price
\$26.98

SHOW PRICE...
\$9⁹⁹
PLU# 4683

Coupon is only valid at the Show in the PEACHTREE WOODWORKING SUPPLY BOOTH. While supplies last, no rain checks.

OVERSTOCK

1ST COME 1ST SERVE

Drill Press Vise

SHOW PRICE...
\$3⁹⁹
PLU# 3300



Coupon is only valid at the Show in the PEACHTREE WOODWORKING SUPPLY BOOTH. While supplies last, no rain checks.

90° Corner Clamp



Catalog Price
\$29.99

SHOW PRICE...
\$19⁹⁹
PLU# 3091

Coupon is only valid at the Show in the PEACHTREE WOODWORKING SUPPLY BOOTH. While supplies last, no rain checks.

FULTON BOX JOINT CUTTER SET



Catalog Price
\$94.99

SHOW PRICE...
\$69⁹⁹
PLU# 3562

Coupon is only valid at the Show in the PEACHTREE WOODWORKING SUPPLY BOOTH. While supplies last, no rain checks.



Peachtree Woodworking Supply Inc.®

"Your One Stop Supply Shop"®

4" to 1" Rubber Adaptor

NEW!
ONLY AT PEACHTREE



SHOW PRICE...
\$4.99
PLU# 542

Steel 2-1/2" Fitting Coupler

NEW!

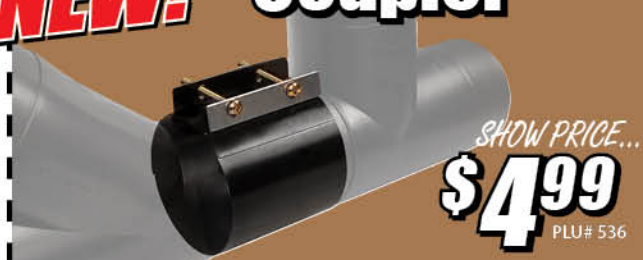

SHOW PRICE...
\$4.99
PLU# 536

Coupon is only valid at the Show in the PEACHTREE WOODWORKING SUPPLY BOOTH. While supplies last, no rain checks.

NEW!

Rubber Coupler



SHOW PRICE...
\$9.99
PLU# 541

Coupon is only valid at the Show in the PEACHTREE WOODWORKING SUPPLY BOOTH. While supplies last, no rain checks.

3 Way Fitting



Catalog Price \$14.99
SHOW PRICE...
\$7.99
PLU# 535

Coupon is only valid at the Show in the PEACHTREE WOODWORKING SUPPLY BOOTH. While supplies last, no rain checks.

4" Cyclone Separator Kit

Catalog Price \$19.99

SHOW PRICE...
\$14.99
PLU# 530



Coupon is only valid at the Show in the PEACHTREE WOODWORKING SUPPLY BOOTH. While supplies last, no rain checks.



FEIN Blade 5 Pack

Catalog Price \$89.95



SHOW PRICE...
\$39.99
PLU# 4060
You SAVE \$49.96

Coupon is only valid at the Show in the PEACHTREE WOODWORKING SUPPLY BOOTH. While supplies last, no rain checks.



Peachtree Woodworking Supply Inc.®

"Your One Stop Supply Shop"®

PREVAL Touch Up Spray System



Catalog Price
\$189.99

\$109.99

PLU# 4389

vFan PORTABLE AIRBRUSH SYSTEM
powered by Preval

OVERSTOCK

1ST COME 1ST SERVE

SUMMIT HVLP Paint Sprayer

\$59.99

PLU# 4760

Catalog Price
\$119.99

SHOW PRICE...



Coupon is only valid at the Show in the PEACHTREE WOODWORKING SUPPLY BOOTH. While supplies last, no rain checks.

Steel Wool 12 Packs



SHOW PRICE...

\$3.99

PLU# 4324
PLU# 4325
PLU# 4326

Magnetic Paint Brush Holder



SHOW PRICE...

\$2.99

PLU# 4206

Coupon is only valid at the Show in the PEACHTREE WOODWORKING SUPPLY BOOTH. While supplies last, no rain checks.

Paint Strainer

10 Pack



Catalog Price
\$2.99

SHOW PRICE...

\$2.25

PLU# 4220

Coupon is only valid at the Show in the PEACHTREE WOODWORKING SUPPLY BOOTH. While supplies last, no rain checks.

Painters Pyramids

36 PACK



Catalog Price
\$19.99

SHOW PRICE...

\$10.99

PLU# 3244

Coupon is only valid at the Show in the PEACHTREE WOODWORKING SUPPLY BOOTH. While supplies last, no rain checks.



See the Revolutionary GRR-Ripper in ACTION!

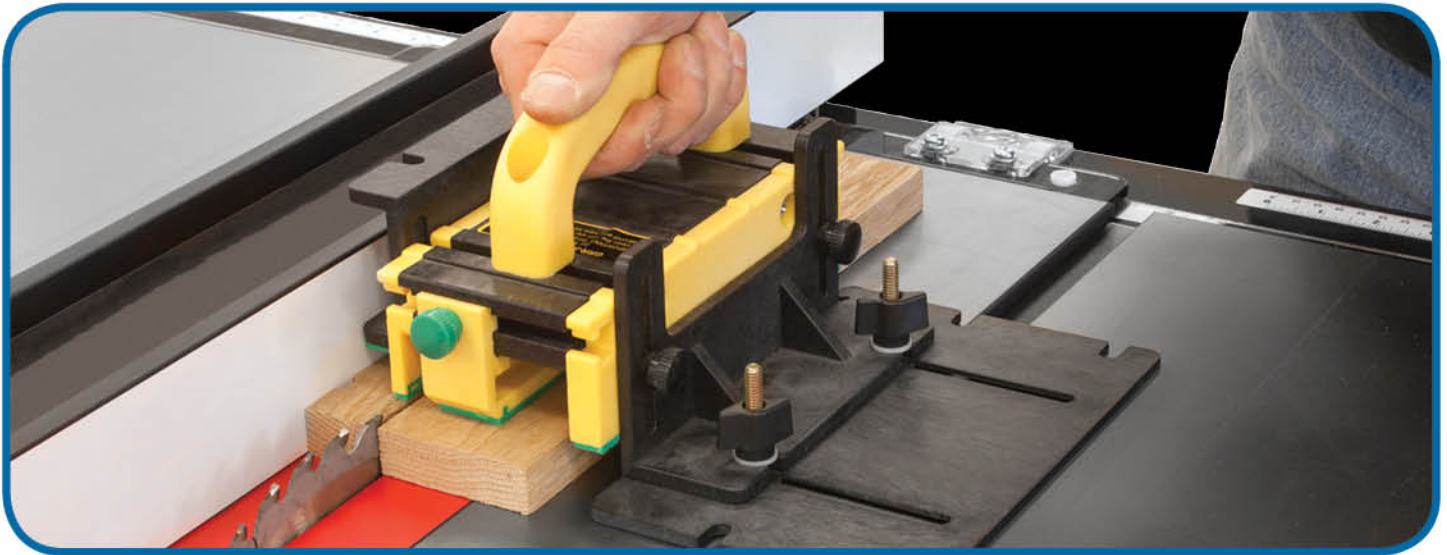

FREE
GRR-RIPPER TUNE-UP KIT
 WITH PURCHASE OF ANY GRR-RIPPER 2 PACK

A
\$999
 VALUE!
 PLU# 1391

Coupon is only valid at the Show in the PEACHTREE WOODWORKING SUPPLY BOOTH. While supplies last, no rain checks.

NEW! **GRR-Rip BLOCK**

Catalog Price \$29.99
 SHOW PRICE...
\$2499
 PLU# 4387

Coupon is only valid at the Show in the PEACHTREE WOODWORKING SUPPLY BOOTH. While supplies last, no rain checks.

NEW! **TAPER JIG & GRR-RIPPER COMBO**

Catalog Price \$219.99
 SHOW PRICE...
\$18999
 PLU# 2907

Coupon is only valid at the Show in the PEACHTREE WOODWORKING SUPPLY BOOTH. While supplies last, no rain checks.

GET **SPLITTERS**

4 EXTRA SPLITTERS
 WITH PURCHASE OF THE MICROJIG SPLITTER COMBO PACK

A
\$1400
 VALUE!

4 extra splitters include 2 each standard kerf splitters and 2 each thin kerf splitters.
 This offer does NOT include the Steel Splitter Pro Sets

Coupon is only valid at the Show in the PEACHTREE WOODWORKING SUPPLY BOOTH. While supplies last, no rain checks.



carter products

Bandsaw Blades and more!

FREE CLASSES

- **GUIDES**
- **STABILIZERS**
- **BANDSAW BLADES**
- **AND MUCH MORE!**

SEE HOW IT ALL WORKS!

LIVE DEMOS!



BUY 4 GET 1 FREE

BANDSAW BLADES



Coupon is only valid at the Show in the CARTER PRODUCTS BOOTH. While supplies last, no rain checks.

BONUS

FREE SACRIFICIAL FENCE
WITH PURCHASE OF MAGFENCE II

CARTER Magfence II

Catalog Price
\$124.98

SHOW PRICE
\$89⁹⁹

Coupon is only valid at the Show in the CARTER PRODUCTS BOOTH. While supplies last, no rain checks.

Carter LOG MILL



Catalog Price
\$139.99

SHOW PRICE...
\$129⁹⁹
PLU# 3721

Coupon is only valid at the Show in the CARTER PRODUCTS BOOTH. While supplies last, no rain checks.



carter products

Bandsaw Blades and more!

CARTER Hollow Roller

FREE
MOUNTING POST
WITH PURCHASE OF HOLLOW ROLLER

SHOW PRICE...

\$359⁹⁹

PLU# 4227



Coupon is only valid at the Show in the CARTER PRODUCTS BOOTH. While supplies last, no rain checks.

Bandsaw Table

Catalog Price
\$159.99

SHOW PRICE...

\$134⁹⁹

PLU# 3602



Coupon is only valid at the Show in the CARTER PRODUCTS BOOTH. While supplies last, no rain checks.

NEW! Multi-Rest

Catalog Price
\$359.99

SHOW PRICE...

\$339⁹⁹

PLU# 4210

Carter Hollow Roller
NOT included



This coupon is only valid at the CARTER PRODUCTS BOOTH at the show. While supplies last. No rain checks.

NEW!

PERFECT SPHERE



BONUS

FREE RISER STUD WITH
PURCHASE OF THE PERFECT SPHERE

- Perfect Spheres
- Spheres up to 14"
- Simple Set up
- Works on most lathes
- Includes a Hunter Tool #4 carbide cutter

SHOW PRICE...

\$324⁹⁹

PLU# 4414





Peachtree Woodworking Supply Inc.®

"Your One Stop Supply Shop"®

Boeshield Value Pack



SHOW PRICE...

\$29⁹⁹

PLU# 3382

Coupon is only valid at the Show in the PEACHTREE WOODWORKING SUPPLY BOOTH. While supplies last, no rain checks.

Shop Tool Tray



Catalog Price
\$24.99

SHOW PRICE...

\$19⁹⁹

PLU# 4292

Coupon is only valid at the Show in the PEACHTREE WOODWORKING SUPPLY BOOTH. While supplies last, no rain checks.

Double Stick Tape



SHOW PRICE...

\$8⁹⁹

PLU# 3599

Coupon is only valid at the Show in the PEACHTREE WOODWORKING SUPPLY BOOTH. While supplies last, no rain checks.

Fast-Joint™

PRECISION JOINERY SYSTEM

Cut, Create, Impress!



SPECIAL SHOW PRICING!



LIVE DEMOS

Router Fluting Jig

Catalog Price
\$69.99

SHOW PRICE...
\$49⁹⁹

PLU# 2969

Coupon is only valid at the Show in the PEACHTREE WOODWORKING SUPPLY BOOTH. While supplies last, no rain checks.



FAST-JOINT mini

NEW!

SHOW PRICE...
\$79⁹⁹

PLU# 4388

Coupon is only valid at the Show in the PEACHTREE WOODWORKING SUPPLY BOOTH. While supplies last, no rain checks.



Offset Router Bit Wrenches

Available for
Bosch, Porter
Cable, Dewalt
and more

SHOW PRICE...
\$12⁹⁹

PLU# 2883

Coupon is only valid at the Show in the PEACHTREE WOODWORKING SUPPLY BOOTH. While supplies last, no rain checks.



Router Bit Rack

Catalog Price
\$14.99

SHOW PRICE...
\$7⁹⁹

PLU# 2262

Coupon is only valid at the Show in the PEACHTREE WOODWORKING SUPPLY BOOTH. While supplies last, no rain checks.



3 pc Ogee Raised Panel Bit Set

Catalog Price
\$43.99

SHOW PRICE...
\$39⁹⁹

PLU# 3842

Coupon is only valid at the Show in the PEACHTREE WOODWORKING SUPPLY BOOTH. While supplies last, no rain checks.

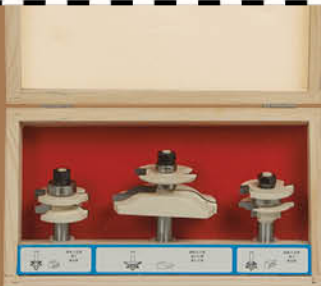

7 pc Roundover Bit Set

Catalog Price
\$33.99

SHOW PRICE...
\$24⁹⁹

PLU# 3845

Coupon is only valid at the Show in the PEACHTREE WOODWORKING SUPPLY BOOTH. While supplies last, no rain checks.



6 pc Straight Bit Set

Catalog Price
\$24.99

SHOW PRICE...
\$16⁹⁹

PLU# 3846

Coupon is only valid at the Show in the PEACHTREE WOODWORKING SUPPLY BOOTH. While supplies last, no rain checks.





Always the Better Idea.

The 3D-Pantograph

from Milescraft is a stencil tracing jig for routers that allows you to carve nearly anything you can imagine. Use the included templates and line drawings (yields carved letters and drawings from 3.2-inches to 4.8-inches), or trace anything that you can print with your computer. We find that children's coloring books provide a great source of ideas and line drawings. Universal design fits ANY router with a 6-inch or smaller base. Some assembly required. For the advanced user, this product is also capable of routing/tracing 3 dimensional carvings and designs.



LIVE DEMOS!
SHOW SPECIALS!

FREE
LETTER SET WITH
PURCHASE OF ANY MILESCRAFT
SIGN MAKING KIT

A
\$9.99
VALUE!

Coupon is only valid at the Show in the PEACHTREE WOODWORKING SUPPLY BOOTH. While supplies last, no rain checks.

FREE
3/8" CORE BOX BIT WITH
PURCHASE OF THE MILESCRAFT
PANTOGRAPH

A
\$9.99
VALUE!

Catalog Price \$69.50
SHOW PRICE...
\$44.99

MILESCRAFT
Pantograph
PLU# 4506

Coupon is only valid at the Show in the PEACHTREE WOODWORKING SUPPLY BOOTH. While supplies last, no rain checks.

Design Inlay Kit

Catalog Price \$44.99
SHOW PRICE...
\$39.99

PLU# 4501

Coupon is only valid at the Show in the PEACHTREE WOODWORKING SUPPLY BOOTH. While supplies last, no rain checks.

FREE
7mm PROFESSIONAL HSS PEN BLANK DRILL BIT
WITH PURCHASE OF THE MILESCRAFT
PEN PRESS **\$14.00**
VALUE!

PEN PRESS
SHOW PRICE...
\$44.99

Milescraft
Pen Press
PLU# 4528

Coupon is only valid at the Show in the PEACHTREE WOODWORKING SUPPLY BOOTH. While supplies last, no rain checks.



Peachtree Woodworking Supply Inc.®

"Your One Stop Supply Shop"®

5/8" Ball Bearing Rollers - 6 pk



SHOW PRICE...
\$17⁹⁹

PLU# 4217

Coupon is only valid at the Show in the PEACHTREE WOODWORKING SUPPLY BOOTH. While supplies last, no rain checks.

Thin Rip Jig



SHOW PRICE...
\$20⁹⁹

PLU# 3096

Coupon is only valid at the Show in the PEACHTREE WOODWORKING SUPPLY BOOTH. While supplies last, no rain checks.

37pc Letter / Number Punch Set



SHOW PRICE...
\$19⁹⁹

PLU# 4295



Coupon is only valid at the Show in the PEACHTREE WOODWORKING SUPPLY BOOTH. While supplies last, no rain checks.

Magnifying LED light



Catalog Price
\$39.99

SHOW PRICE...
\$34⁹⁹

PLU# 4054

Coupon is only valid at the Show in the PEACHTREE WOODWORKING SUPPLY BOOTH. While supplies last, no rain checks.

Asst. Veneer 20 pack



SHOW PRICE...
\$24⁹⁹

PLU# 4380

Coupon is only valid at the Show in the PEACHTREE WOODWORKING SUPPLY BOOTH. While supplies last, no rain checks.

LED Dual Power Light



Catalog Price
\$34.99

SHOW PRICE...
\$29⁹⁹

PLU# 4053



EASY WOOD TOOLS



Choose the tool that best fits your needs

Easy Detailer
Small Details

Easy Rougher
Heavy Cuts
Outside Curves

Easy Finisher
Inside Curves

Illustration not to scale

Woodturning has never been Easier!

Easy Wood Tools offers a series of replaceable carbide cutter woodturning tools that address fatigue, safety and efficiency like no other tools. They are designed to effortlessly remove massive amounts of material on any woodturning project without the need for sharpening. The tools are designed with support directly beneath the cutting edge transferring the cutting pressure downward allowing the lathe to take the pressure that normally would go to your hands and body when roughing.

Stainless Steel Tool Bar

Never rust, and are flat for keeping flat on your lathe tool rest

Made from Maple or Bubinga

depending on the size



Carbide Tips

simply rotate then replace when needed

Easy Grip Handle

Offers several grip locations to keep your hands comfortable



EASY CHUCK "the total package"

Includes an Easy Chuck and ALL 5 Easy Chuck Jaw Sets!



SAVE!

Catalog Price
\$789.94

SHOW PRICE...

\$699⁰⁰

PLU# 4601

EASY START 3 PACK

Catalog Price
\$179.97

SHOW PRICE...
\$159⁹⁹

PLU# 4602



Coupon is only valid at the Show in the PEACHTREE WOODWORKING SUPPLY BOOTH. While supplies last, no rain checks.

10% OFF

ANY MINI, MID SIZE,
FULL SIZE OR PRO SIZE
EASY WOOD TOOL!



Coupon is only valid at the Show in the PEACHTREE WOODWORKING SUPPLY BOOTH. While supplies last, no rain checks.

NEW!

RON BROWN'S BEST

TURNERS LASER GUIDE

Universal Mount, Real Time Vessel Thickness Gauge

Always know where your cutter is

The Turners Laser Guide enables you to know the location of a point on the cutting edge in real time even while the vessel is spinning and material is being removed. It utilizes a laser pointer to indicate the cutter position on the outside of the vessel while the cutter is actually inside the vessel and is otherwise impossible to accurately locate. The Turners Laser Guide can be attached to either the turning tool ferrule or shaft ranging from 3/4" to 1-1/4" in diameter. With the stainless steel supports you can turn vessels 10" deep by 20" in diameter. The Turners Laser Guide can be set to show the position of the cutter or to show the offset to give you the ability to see the wall thickness of your vessel while it is spinning.



SHOW PRICE...
\$79⁹⁹
PLU# 4856

LIVE DEMO!

NEW!

16" Longworth Style Chucks



Catalog Price \$189.99

SHOW PRICE...

\$159⁹⁹
PLU# 4833

More sizes available at the show!

Coupon is only valid at the Show in the RON BROWNS BEST BOOTH. While supplies last, no rain checks.



Turning Mate Mobile Turning Caddy

Catalog Price \$89.99

SHOW PRICE...

\$69⁹⁹
PLU# 4848

Coupon is only valid at the Show in the RON BROWNS BEST BOOTH. While supplies last, no rain checks.

DVD Festival Set

15 DVD's with over 15 hours of instruction
A Great DVD Collection for any turner!



LIMITED Quantities!

SHOW PRICE...

\$79⁹⁹
PLU# 4791

Catalog Price \$245.99

Coupon is only valid at the Show in the RON BROWNS BEST BOOTH. While supplies last, no rain checks.

Finishing Value Pack



SHOW PRICE...

\$24⁹⁹
PLU# 4806

Coupon is only valid at the Show in the PEACHTREE WOODWORKING SUPPLY BOOTH. While supplies last, no rain checks.



Peachtree Woodworking Supply Inc.®

"Your One Stop Supply Shop"®

**Limited
Quantities**



TREND T-4 Router

Catalog Price
\$114.99

SHOW PRICE...

\$69⁹⁹

PLU# 4941

Coupon is only valid at the Show in the PEACHTREE WOODWORKING SUPPLY BOOTH. While supplies last, no rain checks.

Mother of Pearl Pen Blank 4 Pack



Catalog Price
\$66.99

SHOW PRICE...

\$27⁹⁹

PLU# 4866

Coupon is only valid at the Show in the RON BROWNS BEST BOOTH. While supplies last, no rain checks.

**RON
BROWN'S BEST**

Speed Gouge



Catalog Price
\$24.99

SHOW PRICE...

\$19⁹⁹

PLU# 4828

Coupon is only valid at the Show in the RON BROWNS BEST BOOTH. While supplies last, no rain checks.

Carbon Fiber Pen Blank 4 Pack

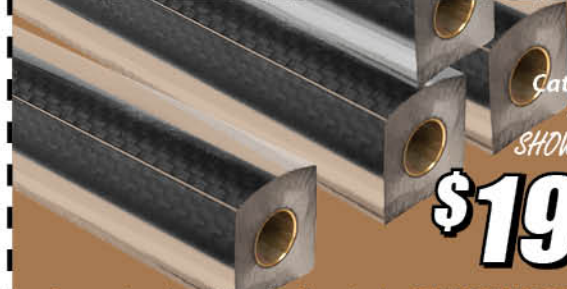

Catalog Price
\$50.99

SHOW PRICE...

\$19⁹⁹

PLU# 4865

Coupon is only valid at the Show in the RON BROWNS BEST BOOTH. While supplies last, no rain checks.

Savannah
Turning Tools

8 pc Turning Tool Set



\$74⁹⁹

PLU# 4817

Coupon is only valid at the Show in the RON BROWNS BEST BOOTH. While supplies last, no rain checks.

**RON
BROWN'S BEST**

Rotary Texturing Tool



Catalog Price
\$59.99

SHOW PRICE...

\$49⁹⁹

PLU# 4869

Coupon is only valid at the Show in the RON BROWNS BEST BOOTH. While supplies last, no rain checks.



Peachtree Woodworking Supply Inc.®

"Your One Stop Supply Shop"®

High Pressure Glue Injector



Catalog Price
\$24.99

SHOW PRICE...
\$15⁹⁹

PLU# 1080

Coupon is only valid at the Show in the PEACHTREE WOODWORKING SUPPLY BOOTH. While supplies last, no rain checks.

Large Woodworkers Drill Press Table



Catalog Price
\$159.99

SHOW PRICE...
\$109⁹⁹

PLU# 4216

Coupon is only valid at the Show in the PEACHTREE WOODWORKING SUPPLY BOOTH. While supplies last, no rain checks.

8 Pocket Bib Apron

Catalog Price
\$19.99

SHOW PRICE...
\$14⁹⁹

PLU# 1452



Coupon is only valid at the Show in the PEACHTREE WOODWORKING SUPPLY BOOTH. While supplies last, no rain checks.

Drill Press Laser Guide



Catalog Price
\$39.99

SHOW PRICE...
\$34⁹⁹

PLU# 929

Coupon is only valid at the Show in the PEACHTREE WOODWORKING SUPPLY BOOTH. While supplies last, no rain checks.

Double End Featherboard

Catalog Price
\$17.99

SHOW PRICE...
\$14⁹⁹

PLU# 1230



Coupon is only valid at the Show in the PEACHTREE WOODWORKING SUPPLY BOOTH. While supplies last, no rain checks.

50 Piece mini drill bit set



SHOW PRICE...

\$10⁹⁹

PLU# 803

Coupon is only valid at the Show in the PEACHTREE WOODWORKING SUPPLY BOOTH. While supplies last, no rain checks.



Peachtree Woodworking Supply Inc.®

"Your One Stop Supply Shop"®

3pc Wire Brush Set

SHOW PRICE...

\$299

PLU# 4224



Coupon is only valid at the Show in the PEACHTREE WOODWORKING SUPPLY BOOTH. While supplies last, no rain checks.

129 PC Hardware Kits

Available in 1/4" and 5/16" Kits

Catalog Price \$79.99

SHOW PRICE...

\$49⁹⁹

PLU# 2063
PLU# 2065



Coupon is only valid at the Show in the PEACHTREE WOODWORKING SUPPLY BOOTH. While supplies last, no rain checks.

4pc Chisel Set

SHOW PRICE...

\$19⁹⁹

PLU# 4196



Coupon is only valid at the Show in the PEACHTREE WOODWORKING SUPPLY BOOTH. While supplies last, no rain checks.

100 piece Rare Earth Magnet Pack

Catalog Price \$45.99

SHOW PRICE...

\$24⁹⁹

PLU# 923



Coupon is only valid at the Show in the PEACHTREE WOODWORKING SUPPLY BOOTH. While supplies last, no rain checks.

LOC-BLOCKS 8 PACK

SHOW PRICE...

\$20⁰⁰

PLU# 4383

Catalog Price \$30.00



Coupon is only valid at the Show in the PEACHTREE WOODWORKING SUPPLY BOOTH. While supplies last, no rain checks.

Magnetic Nail Starter

SHOW PRICE...

\$199

PLU# 4207



Coupon is only valid at the Show in the PEACHTREE WOODWORKING SUPPLY BOOTH. While supplies last, no rain checks.



Peachtree Woodworking Supply Inc.®

"Your One Stop Supply Shop"®

iGAGING 12" Digital Protractor



Catalog Price \$24.99
**SHOW PRICE...
\$19.99**

PLU# 1567

Coupon is only valid at the Show in the PEACHTREE WOODWORKING SUPPLY BOOTH. While supplies last, no rain checks.

OVERSTOCK 1ST COME 1ST SERVE

Converter Pro Calculator



Catalog Price \$4.99
**SHOW PRICE...
\$4.99**

PLU# 3077

Coupon is only valid at the Show in the PEACHTREE WOODWORKING SUPPLY BOOTH. While supplies last, no rain checks.

NEW!

iGAGING

Digital Marking Gauge



Catalog Price \$44.99

SHOW PRICE...
\$34.99

PLU# 2265

Coupon is only valid at the Show in the PEACHTREE WOODWORKING SUPPLY BOOTH. While supplies last, no rain checks.

Foldable Workshop Earmuffs



Ear muffs are sold as a single pair, folded ear muffs are shown for illustration purposes only.

Catalog Price \$14.99
**SHOW PRICE...
\$9.99**

per pair

PLU# 4205

Coupon is only valid at the Show in the PEACHTREE WOODWORKING SUPPLY BOOTH. While supplies last, no rain checks.

iGAGING

6" DIGITAL CALIPER

LARGE
easy to see display

Actual Caliper Color may Vary



Catalog Price \$34.99

SHOW PRICE...
\$29.99

PLU# 1560

This coupon is only valid at the PEACHTREE WOODWORKING SUPPLY BOOTH at the show and may not be used for any other purchase

Power Push Block

Catalog Price \$29.99

SHOW PRICE...
\$19.99

PLU# 1777



Coupon is only valid at the Show in the PEACHTREE WOODWORKING SUPPLY BOOTH. While supplies last, no rain checks.



Peachtree Woodworking Supply Inc.®

"Your One Stop Supply Shop"®

Edge Banding Roller



SHOW PRICE...

\$499

PLU# 4382

Coupon is only valid at the Show in the PEACHTREE WOODWORKING SUPPLY BOOTH. While supplies last, no rain checks.

LOC-BLOCK non slip pads



8 Pack

SHOW PRICE...

\$499

PLU# 1389

Coupon is only valid at the Show in the PEACHTREE WOODWORKING SUPPLY BOOTH. While supplies last, no rain checks.

OVERSTOCK

1ST COME 1ST SERVE

Irwin Handi Clamps

SHOW PRICE...

.99cents

PLU# 4684



Coupon is only valid at the Show in the PEACHTREE WOODWORKING SUPPLY BOOTH. While supplies last, no rain checks.

Starbond Glue Kit



SHOW PRICE...

\$2999

PLU# 4318

Coupon is only valid at the Show in the PEACHTREE WOODWORKING SUPPLY BOOTH. While supplies last, no rain checks.

MT-2 Lathe Drill Chuck

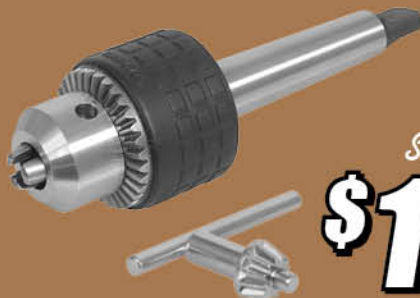

Catalog Price
\$29.99

SHOW PRICE...

\$1999

PLU# 4853

Coupon is only valid at the Show in the PEACHTREE WOODWORKING SUPPLY BOOTH. While supplies last, no rain checks.

Microfiber Cloth 3 Pack



SHOW PRICE...

\$1299

PLU# 4763

Coupon is only valid at the Show in the PEACHTREE WOODWORKING SUPPLY BOOTH. While supplies last, no rain checks.

Woodworking Library

Sponsored by  Taunton



Books, Plans, DVD's & more!

Find books about turning, table-saws, routers, dust collection, and more!

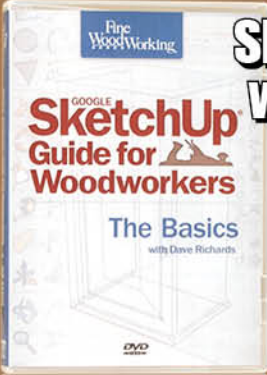

SketchUp Guide for woodworkers DVD

Catalog Price \$16.99
SHOW PRICE...
\$9.99 PLU# 3420

This coupon is only valid at the Peachtree Woodworking Supply - Woodworking Library Booth at the show and may not be combined with any other offer

Buy 3 or more Books
at regular price



and Receive **\$500 OFF**
Your Purchase
NOT VALID on Red Tagged Books

This coupon is only valid at the Peachtree Woodworking Supply - Woodworking Library Booth at the show and may not be combined with any other offer



FREE Fine Woodworking Back Issue for the 1st 100 customers!

This coupon is only valid at the Peachtree Woodworking Supply - Woodworking Library Booth at the show. While supplies last, No rain checks.

1st Edition Fine Woodworking Magazine Printed Copy



Catalog Price \$19.95
SHOW PRICE...
\$9.99 PLU# 1860

 Taunton